

# TMV-1350A/1600A

## Vertical Machining Center



**Tongtai Tongtai Machine & Tool Co., Ltd.**

Headquarters

No.3, Luke 3rd Rd., Luzhu Dist., Kaohsiung City 82151, Taiwan  
 TEL : 886-7-9761588  
 FAX : 886-7-9761589, 886-7-9761590  
 Website : www.tongtai.com.tw

Taoyuan Office	TEL : 886-3-4551399	FAX : 886-3-4559730
Taichung Office	TEL : 886-4-23589600	FAX : 886-4-23589993
Japan Branch	TEL : 81-4-71438355	FAX : 81-4-71438360
Europe Branch	TEL : 31-161-454639	FAX : 31-161-454768
Malaysia Branch	TEL : 603-78597113	FAX : 603-78597115
Vietnam Office	TEL : 84-4-62766090	
Thailand Office	TEL : 66-2-7443440	FAX : 66-2-3986518
Indonesia Office	TEL : 62-21-45850875	FAX : 62-21-45850876

Affiliates

**Honor Seiki Co., Ltd.**  
 TEL: 886-7-9759888  
 FAX: 886-7-9759999  
 Website : www.honorseiki.com.tw

**Asia Pacific Elite Corp.**  
 TEL: 886-4-23589313  
 FAX: 886-4-23588913  
 Website : www.apecnc.com

**Quick-Tech Machinery Co., Ltd**  
 TEL: 886-6-3841155  
 FAX: 886-6-3841177  
 Website : www.quicktech.com.tw



China Operation Center

**Shuzhou Tong-yu Machine & Tool Co., Ltd.**

No.555 Huahong Road, Economic Development Zone,  
 Songling Town, Wujiang City, Jiangsu Province, China  
 TEL : 86-512-63430168  
 FAX : 86-512-63431622  
 E-mail : sales@tong-yu.com.cn

Wuhan Branch	TEL : 86-27-59409109	FAX : 86-27-59409110
Chongqing Branch	TEL : 86-23-67865925	FAX : 86-23-67867717
Guandong Branch	TEL : 86-755-27222119	FAX : 86-755-27222115
Tianjin Branch	TEL : 86-22-24417640	FAX : 86-22-24416738
Shanghai Office	TEL : 86-21-24208138	FAX : 86-21-34073262
Shenyang Office	TEL : 86-24-24142968	FAX : 86-24-24115782

# TMV-1350A/1600A

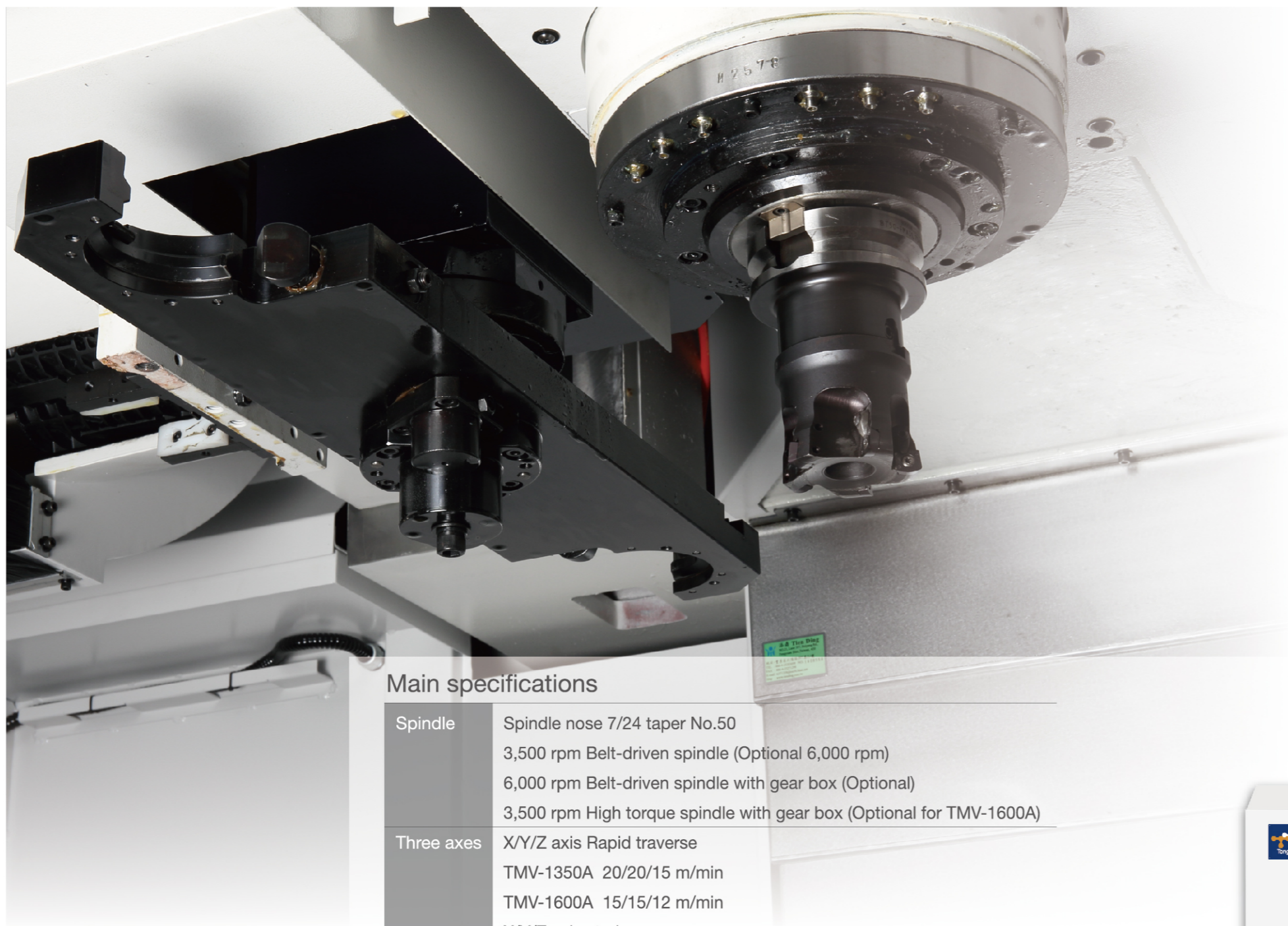

## High rigidity and heavy duty cutting performance

With high rigidity box-way design, long machining stroke and high torque output spindle, TMV-1350A/6000A is suitable for heavy duty cutting.

## High efficiency chip disposal

Equipped with two chip augers and flushing system, these can easily dispose chips to prevent chip storing while plenty of chips were generated during machining.

### Main specifications

Spindle	Spindle nose 7/24 taper No.50 3,500 rpm Belt-driven spindle (Optional 6,000 rpm) 6,000 rpm Belt-driven spindle with gear box (Optional) 3,500 rpm High torque spindle with gear box (Optional for TMV-1600A)
Three axes	X/Y/Z axis Rapid traverse TMV-1350A 20/20/15 m/min TMV-1600A 15/15/12 m/min X/Y/Z axis stroke TMV-1350A 1,350/750/700 mm TMV-1600A 1,600/800/700 mm High rigidity box-way structure X/Y/Z axis Ø50 mm high precision ballscrews
ATC	TMV-1350A Tool capacity 24 pcs (Optional 32 pcs) TMV-1600A Tool capacity 32 pcs (Optional 40 pcs)

### CONTENTS

- 03 Main structure
- 05 Machining ability
- 06 Operation • Maintenance
- 07 Peripheral accessories
- 08 Spindle output and torque chart
- 09 Standard/optional accessories
- 10 Machine dimension • Specification



# Main structure

## High rigidity box-way structure

### Stroke

X/Y/Z axis

TMV-1350 1,350/750/700 mm

TMV-1600 1,600/800/700 mm

### Rapid traverse

X/Y/Z axis

TMV-1350 20/20/15 m/min

TMV-1600 15/15/12 m/min

Z axis is blanced by counter-weight to reduce the loading of servo motor and improve its machining precision.

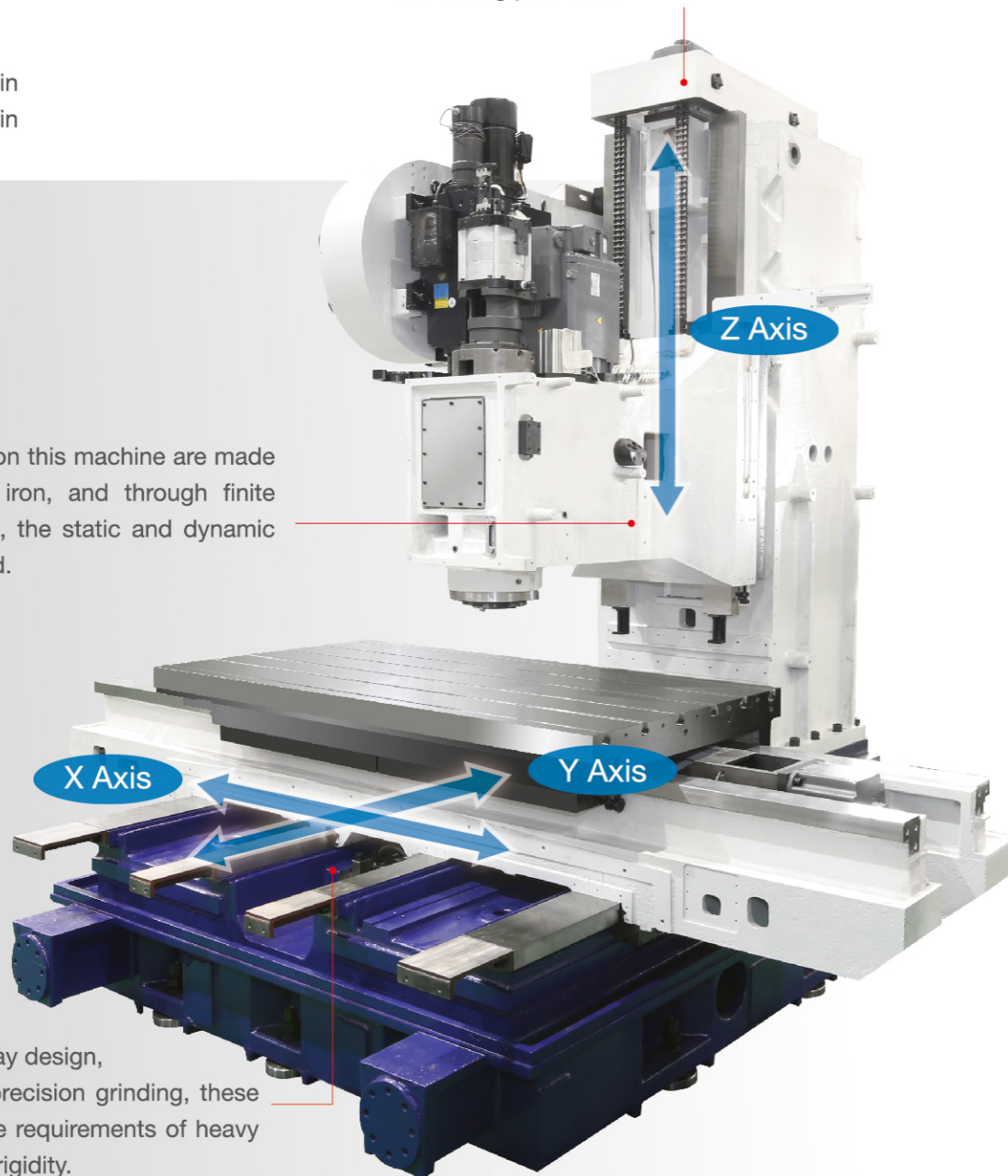

Casting components on this machine are made of high quality cast iron, and through finite element analysis(FEA), the static and dynamic rigidity can be ensured.

- With huge size box-way design, heat treatment, and precision grinding, these features can reach the requirements of heavy duty cutting and high rigidity.
- Turcite-B and precise scraping is applied on slide surface of box-way to ensure the best lubrication effect.
- The Y axis employs four guideways to offer superior support of the X axis saddle and best accuracy.

## High torque spindle with gear box

Gear box type spindle is equipped with cooler, which can restrain the heating occurred by gear box, reduce the thermal deformation and extend spindle life.

Standard 3,500 rpm belt-driven spindle with nose BT50 can optionally be changed as gear box type spindle, to reach the maximum output torque 731 Nm providing higher torque for heavy duty cutting.

Specification	TMV-1350A / TMV-1600A			TMV-1600A
Max. speed	3,500 rpm	6,000 rpm	6,000 rpm	3,500 rpm
Driven Type	Belt-driven	Belt-driven	Belt + gear box	Gear box
Horse power	15/11 kW	15/11 kW	15/11 kW	15/11 kW
Torque	239/175 Nm	191/140 Nm	382/280 Nm	731/536 Nm



## ATC

With cam type tool changer, it can achieve high precision and low noise; moreover, the stable tool clamping can ensure spindle accuracy and extend bearing life.

T to T 5.1 sec

Tool capacity

TMV-1350A 24 pcs (Optional 32 pcs)

TMV-1600A 32 pcs (Optional 40 pcs)

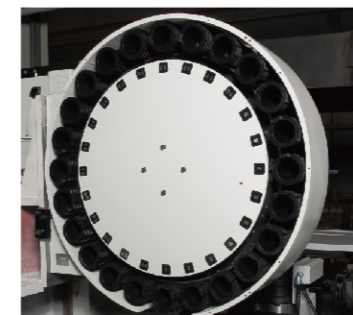

• 24 pcs

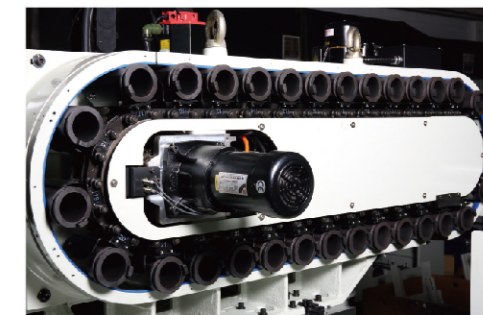

• 32 pcs

## Working area

Specification	TMV-1350A	TMV-1600A
Table size	1,500×750 mm	1,700×850 mm
Max. table loading	1,300 kg	2,000 kg

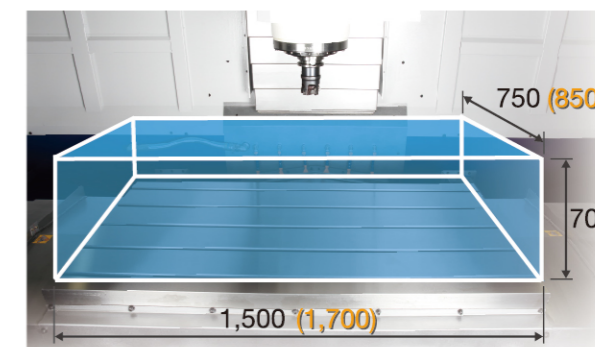

Unit : mm

## Milling ability

TMV-1350A Belt-driven Spindle Material : S45C

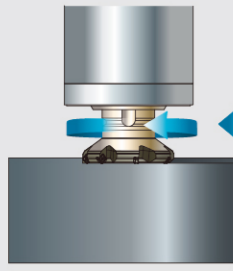

Milling	
Chip removal rate	342 cm <sup>3</sup> /min
Tool	Ø125 (9 teeth)
Spindle speed	600 rpm
Traverse	1,623 mm/min
Widening	100 mm
Cutting	2 mm

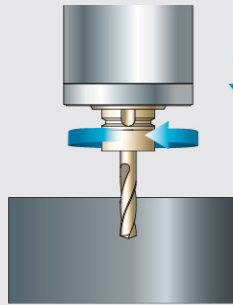
Drilling	
Chip removal rate	143 cm <sup>3</sup> /min
Tool	Ø65
Spindle speed	122 rpm
Traverse	43 mm/min

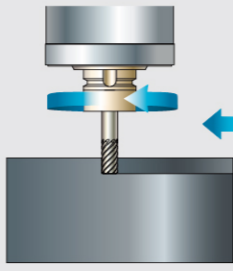

Milling	
Chip removal rate	238 cm <sup>3</sup> /min
Tool	Ø45 (6 teeth)
Spindle speed	700 rpm
Traverse	1,060 mm/min
Widening	45 mm
Cutting	5 mm

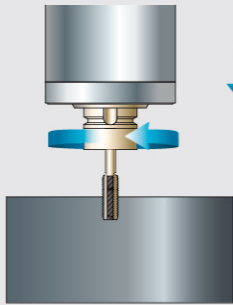

Tapping	
Chip removal rate	M30×P2
Tool	150 rpm
Spindle speed	300 mm/min

TMV-1600A Gear type Spindle Material : S45C

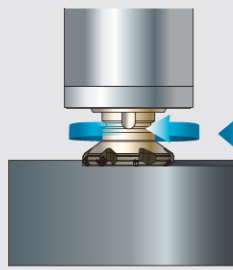

Milling	
Chip removal rate	458 cm <sup>3</sup> /min
Tool	Ø125 (9 teeth)
Spindle speed	254 rpm
Traverse	537 mm/min
Widening	100 mm
Cutting	8 mm

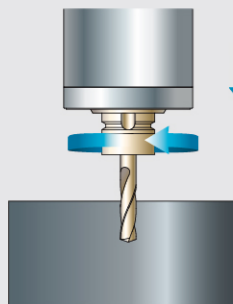
Drilling	
Chip removal rate	143 cm <sup>3</sup> /min
Tool	Ø65
Spindle speed	122 rpm
Traverse	43 mm/min

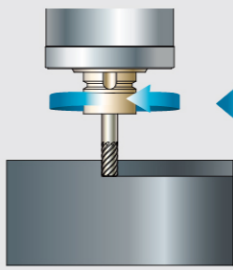

Milling	
Chip removal rate	286 cm <sup>3</sup> /min
Tool	Ø45 (6 teeth)
Spindle speed	350 rpm
Traverse	636 mm/min
Widening	45 mm
Cutting	10 mm

Tapping	
Chip removal rate	M30×P2
Tool	150 rpm
Spindle speed	300 mm/min

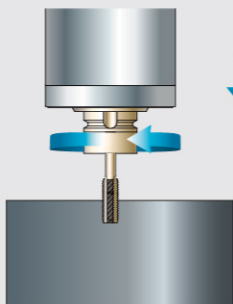
## Operation · Maintenance

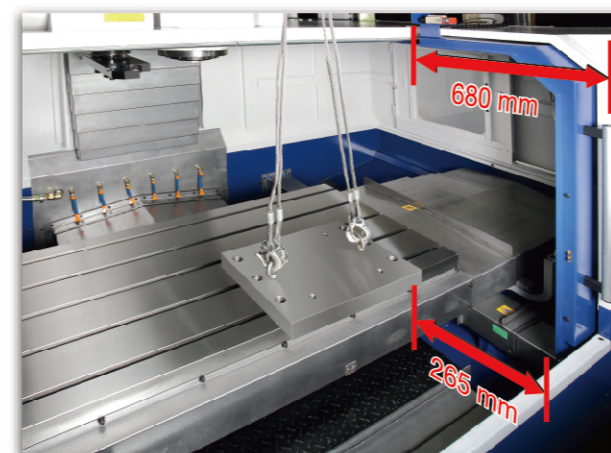

With the door opened, the top side is wide open, providing a wide space for loading work. The distance and height of table are very ergonomic. It provides the operator a very comfortable and convenient working area.



The control panel can be rotated 90°, besides, as equipped with manual pulse generator, operator can adjust for the best view while working.



The wide door opening provides a spacious area for the during operation and processing maintenance.

Door opening width  
 TMV-1350A 1,490 mm  
 TMV-1600A 1,870 mm



Pneumatic unit, lubricant pump, and some maintenance items are located on the rear left side of machine, with easy access.

## Peripheral accessories

### Chip disposal

Equipped with two chip augers and flushing system, it can easily remove chips to prevent chip storing, even plenty of chips were generated during machining.

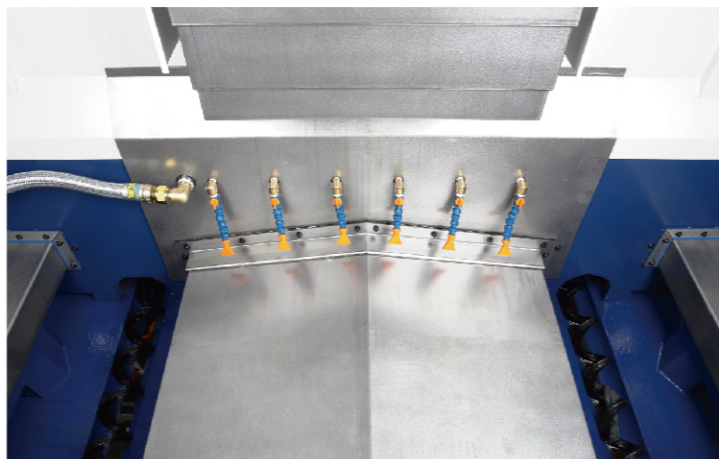

### Chip conveyor (Optional)

According to different materials and chip size, Tongtai provide various chip conveyors for the best chip disposal.

Specification	Steel		Cast iron		Aluminum/ Non-ferrous metal		
	Long/Curl chips	Short chips	Powder chips	Short chips	Long/Curl chips	Short chips	Powder chips
Hinge type	O	X	X	X	O	X	X
Scraper type	X	O	O	O	X	O	O
Magnetic scraper type	O	O	O	O	X	X	X

O : Suitable X : Non-suitable

Short chips: Chips shorter than 60 mm or ball type chips smaller than Ø40 mm.

Curl long chips: Chips' length is longer than short ones.

### Coolant Through Spindle

Coolant through spindle increases the efficiency of chip disposal and extends the tool life.

Discharge pressure: 15/40/70 bar  
(1.5/4.0/7.0 MPa)

Filtering accuracy: 40 µm

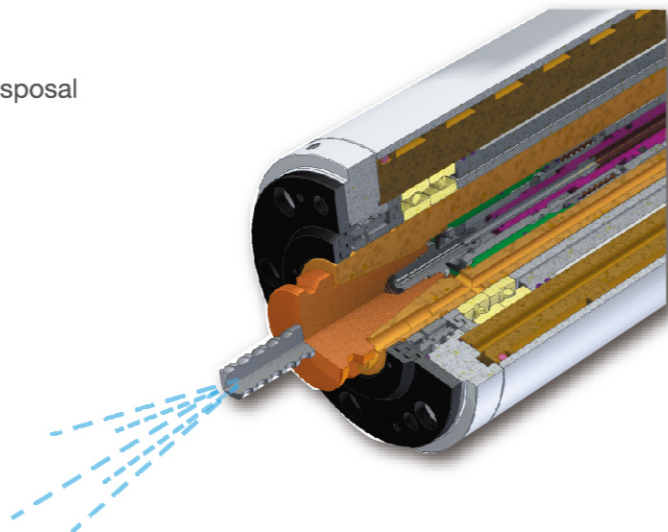

## Spindle output and torque chart

3,500 rpm Belt-driven type

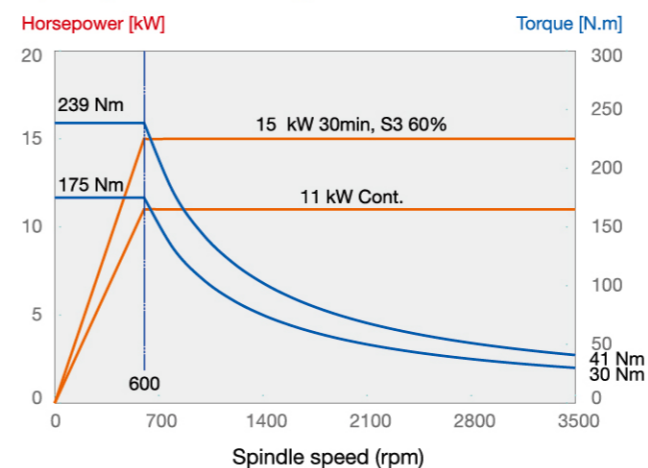

6,000 rpm Belt-driven type

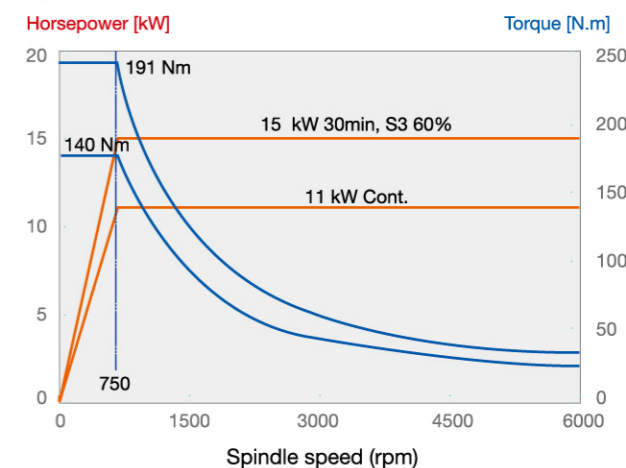

6,000 rpm Belt-driven with gear box (Low-winding)

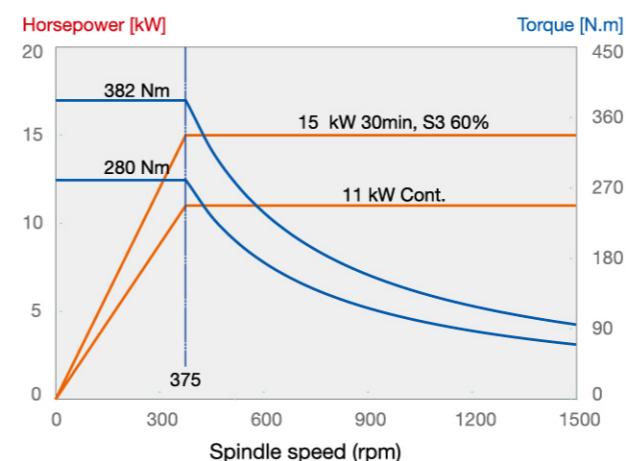

(High-winding)

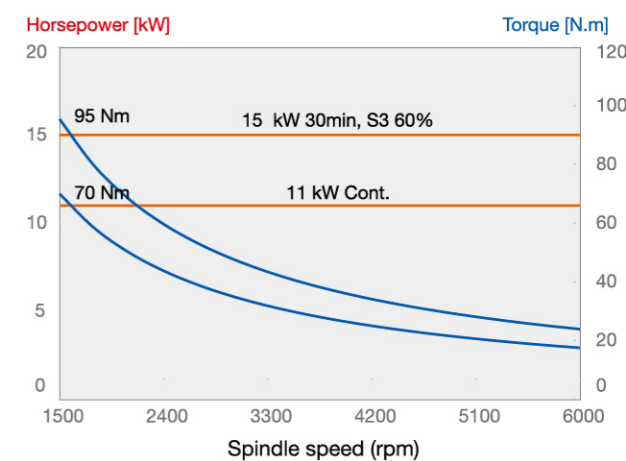

3,500 rpm Gear box type (Optional for TMV-1600A) (Low-winding)

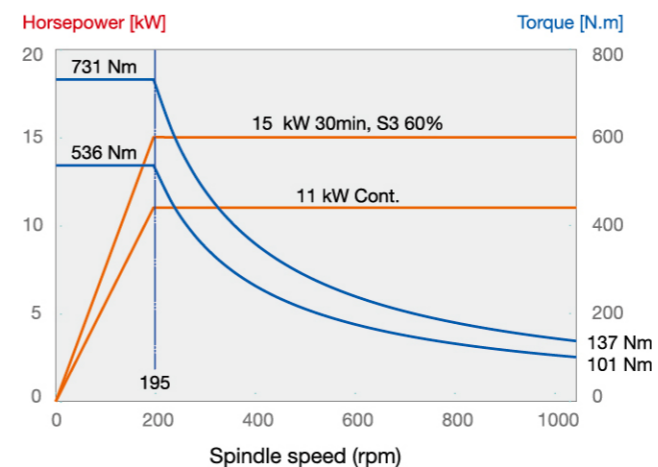

(High-winding)

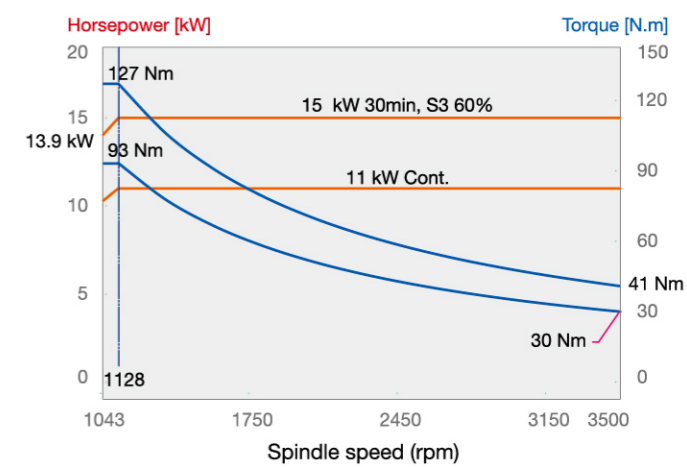

## Standard/optional accessories

		Standard	Optional accessories
Tool Shank	BT-50	●	
	HSK-A100		○
Coolant through spindle pump	15 bar		○
	40 bar		○
	70 bar		○
Cooling system	Spindle cooler		○
	Hydraulic temperature control system		○
	Coolant temperature control system		○
	Air conditioner for electrical cabinet		○
Chip conveyor	Two chip augers	●	
	Bed flushing pump	●	
	Scraper type conveyor		○
	Magnetic scraper type conveyor		○
	Hinge type conveyor		○
Lubrication system	General lubrication system	●	
	LHL integrated lubrication system		○
Positioning accuracy system	Three axes linear scale 5μ resolution		○
	Three axes linear scale 3μ resolution		○
	Three axes magnetic scale 5μ resolution		○
Tool measuring system	Tongtai made touch type tool breakage detector		○
	Laser type tool measurement		○
4th axis rotatry table			○
Others	Workpiece measuring device		○
	Machining air blow		○
	Air gun		○
	Coolant gun		○
	Oil skimmer		○
	Oil mist collector		○
	Automatic door		○
Controller	FANUC 0i-M	●	
	FANUC 31i-M		○

## Machine dimensions • Specifications

### Machine dimensions

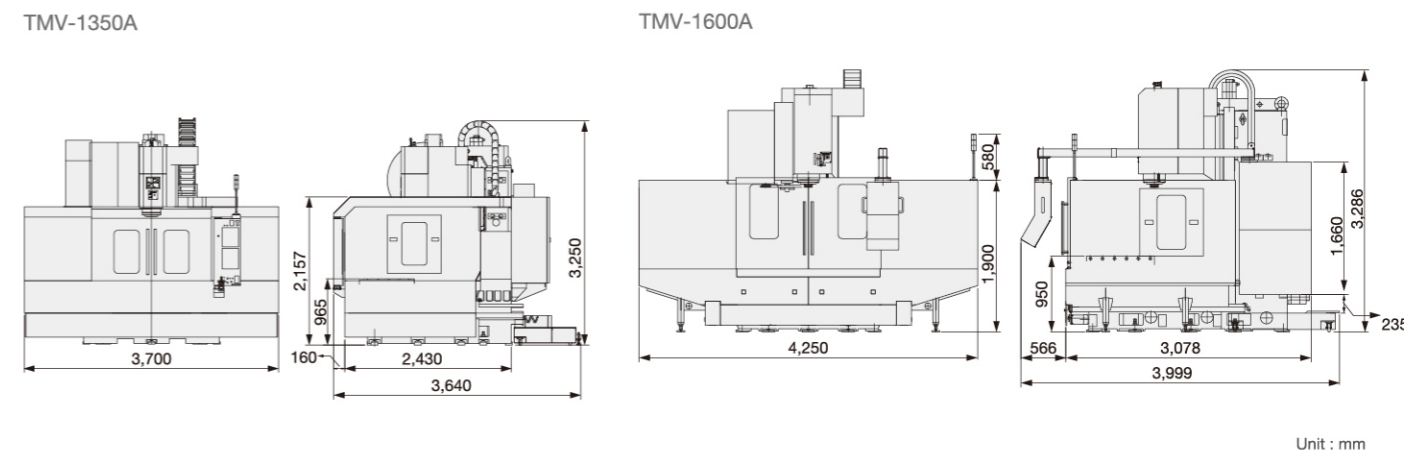

### Specifications

Item	Specification	Unit	TMV-1350A	TMV-1600A
Table	Table size (LxW)	mm	1,500x750	1,700x850
	Max.loading capacity	kg	1,300	2,000
	Table height from floor	mm	950	
	T-slot (size×No.)	mm	18×5	18×6
Spindle	Spindle taper		7/24 Taper No.50	
	Spindle speed	rpm	Belt-driven type 3,500(Opt. 6,000) (Opt. Belt-driven with gear box 6,000) (Optional for TMV-1600A Gear box type 3,500)	
Stroke	X/Y/Z axis stroke	mm	1,350/750/700	1,600/800/700
	Spindle nose to table	mm	200~900	
Feed	X/Y/Z axis rapid traverse	m/min	20/20/15	15/15/12
	Cutting feedrate	mm/min	1~5,000	
ATC	Tool shank		BT-50 (Opt. HSK-A100)	
	Tool capacity	pcs	24 (Opt. 32)	32 (Opt. 40)
	Max. tool diameter	mm	Ø110 (Opt. Ø125)	
	Max. tool diameter(w/o adjacent tool)	mm	Ø200 (Opt. Ø220)	
	Max. tool length	mm	300	
	Max. tool weight	kg	15	
Motor	Spindle motor	kW	11/15	
	X/Y/Z servo motor	kW	4.0/4.0/7.0	
	Coolant motor	kW	0.37	
Controller			FANUC 0i-M	
Machine size	W×L×H	mm	3,700×3,640×3,250	4,250×3,433×3,286
	Weight	kg	13,000	15,000

©Specifications may be changed without prior notice